



MULTISCAFF

Information Booklet



Supplied by:



EQUIPTEC

Index

	Page
0.7m Compact Towers	3-7
Compact section includes...	
<ul style="list-style-type: none"> • Value bundle deals • Bundle upgrade kits • Doorway towers 	1.0m High Page 4 2.0m High Page 5 3.0m High Page 6 4.0m High Page 7
0.7m Single Width Mobile Towers	8-16
Single width mobile tower section includes...	
<ul style="list-style-type: none"> • Economy mobile towers • With extra deck for safe assembly • Full spec with all the berries 	2.0m High Page 9 2.5m High Page 10 3.0m High Page 11-12 3.5m High Page 12 4.0m High Page 13-14 4.5m High Page 14 5.0m High Page 15 6.0m High Page 16
1.3m Double Width Mobile Towers	17-30
Double width mobile tower section includes...	
<ul style="list-style-type: none"> • Value bundle deals • Economy mobile towers • With extra single decks for safe assembly • With extra double decks for safe assembly • Full spec with all the berries 	2.0m High Page 18-19 2.5m High Page 19 3.0m High Page 20 3.5m High Page 21-22 4.0m High Page 23-24 4.5m High Page 24 5.0m High Page 25-26 5.5m High Page 26 6.0m High Page 27-28 6.5m High Page 28 7.0m High Page 29 8.0m High Page 30
Tradesmen Multi Packs	31-32
Quik-Guard Roof Edge Protection	33-35
<ul style="list-style-type: none"> • 12 lineal metres • 36 lineal metres • 68 lineal metres • 104 lineal metress • 200 lineal metres 	Page 34 Page 34 Page 34 Page 35 Page 35

Index

	Page
MultiScaff Components	36-42
• Standard Frames - 0.7m-3.0m wide	Page 37
• Special Frames	Page 38
• Walkthru Frames	Page 38
• Braces	Page 39
• Handrail Trusses	Page 39
• Outriggers	Page 39
• Platforms	Page 40
• Scaffold Ladders	Page 40
• Castors and Plates	Page 40
• Toeboards	Page 41
• Quik-Guard REP	Page 41
• Parts	Page 42

0.7m Compact Towers

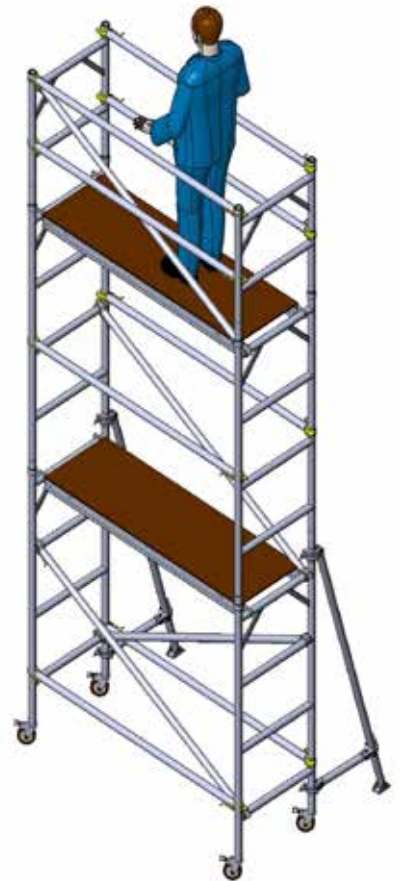

0.7m Compact Towers

Height 1.0m

Platform height: 0.96m
Overall tower height including handrails: 1.96m
Maximum reach/working height: 2.96m

Mobile Tower - Basic Compact Starter Pack

Component List

- 4 - Horizontal Brace
- 1 - Diagonal Brace
- 2 - 0.7m x 1.8m Door Base Frame
- 1 - Access Platform
- 4 - 125mm Non-Adjustable Castor



Length

2.0m

Code

BCD1

Approx Wgt

52kg

Mobile Tower - Doorway 1

Component List

- 4 - Horizontal Brace
- 1 - Diagonal Brace
- 2 - 0.7m x 1.8m Door Base Frame
- 1 - Access Platform
- 4 - 125mm Non-Adjustable Castor
- 2 - End Toeboard
- 2 - Side Toeboard



Length

2.0m

Code

Doorway 1

Approx Wgt

64kg

0.7m Compact Towers

Height 2.0m

Platform height: 1.89m
 Overall tower height including handrails: 2.89m
 Maximum reach/working height: 3.89m

Mobile Tower - Basic Compact Plus Pack

- Component List**
- 6 - Horizontal Brace
 - 2 - Diagonal Brace
 - 2 - 0.7m x 1.8m Door Base Frame
 - 2 - 0.7m x 0.9m Upper Frame
 - 1 - Access Platform
 - 4 - 125mm Non-Adjustable Castor
 - 2 - Outrigger Prop 1.2m



Length	Code	Approx Wgt
2.0m	BCD2	76kg

Components Pack - Upgrade Basic Starter to Plus

- Component List**
- 2 - Horizontal Brace
 - 1 - Diagonal Brace
 - 2 - 0.7m x 0.9m Upper Frame
 - 2 - Outrigger Prop 1.2m

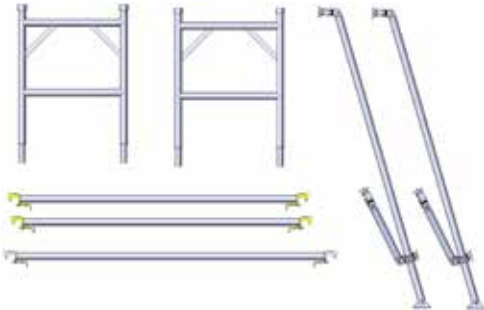

Length	Code	Approx Wgt
	BCDK2	25kg

Mobile Tower - Doorway 2

- Component List**
- 6 - Horizontal Brace
 - 2 - Diagonal Brace
 - 2 - 0.7m x 1.8m Door Base Frame
 - 2 - 0.7m x 0.9m Upper Frame
 - 1 - Access Platform
 - 4 - 125mm Non-Adjustable Castor
 - 2 - End Toeboard
 - 2 - Side Toeboard
 - 2 - Outrigger Prop 1.2m



Length	Code	Approx Wgt
2.0m	Doorway 2	88kg

0.7m Compact Towers

Height 3.0m

Platform height: 2.82m
 Overall tower height including handrails: 3.82m
 Maximum reach/working height: 4.82m

Mobile Tower - Basic Compact Double Up Pack

Component List	Length	Code	Approx Wgt
8 - Horizontal Brace 3 - Diagonal Brace 4 - 0.7m x 1.8m Door Base Frame 2 - Access Platform 8 - 125mm Non-Adjustable Castor 2 - Outrigger Prop 1.2m 4 - Doorway Frame Connector	2.0m	BCD3	117kg



Components Pack - Upgrade 2 x Basic Starter to Double Up

Component List	Length	Code	Approx Wgt
1 - Diagonal Brace 2 - Outrigger Prop 1.2m 4 - Doorway Frame Connector		BCDK3	14kg

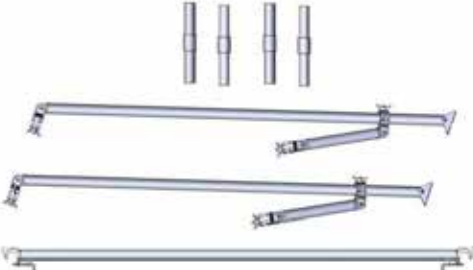

Mobile Tower - Doorway 3

Component List	Length	Code	Approx Wgt
12 - Horizontal Brace 4 - Diagonal Brace 4 - 0.7m x 1.8m Door Base Frame 2 - Access Platform 8 - 125mm Non-Adjustable Castor 2 - End Toeboard 2 - Side Toeboard 2 - Outrigger Prop 1.2m 4 - Doorway Frame Connector	2.0m	Doorway 3	141kg



0.7m Compact Towers

Height 4.0m

Platform height: 3.75m
 Overall tower height including handrails: 4.75m
 Maximum reach/working height: 5.75m

Mobile Tower - Basic Compact Double Plus Pack

Component List	Length	Code	Approx Wgt
<ul style="list-style-type: none"> 8 - Horizontal Brace 4 - Diagonal Brace 4 - 0.7m x 1.8m Door Base Frame 2 - 0.7m x 0.9m Upper Frame 2 - Access Platform 8 - 125mm Non-Adjustable Castor 2 - Outrigger Prop 1.2m 4 - Doorway Frame Connector 	2.0m	BCD4	129kg



Components Pack - Upgrade 2 x Basic Starter to Double Plus

Component List	Length	Code	Approx Wgt
<ul style="list-style-type: none"> 2 - Horizontal Brace 2 - Diagonal Brace 2 - Outrigger Prop 1.2m 4 - Doorway Frame Connector 		BCDK4	22kg

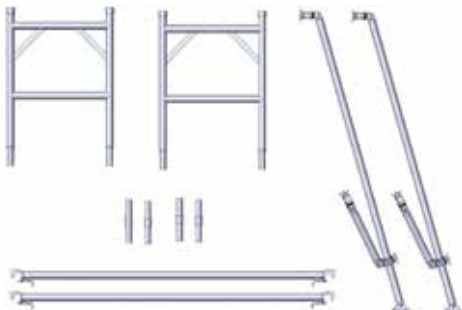

Mobile Tower - Doorway 4

Component List	Length	Code	Approx Wgt
<ul style="list-style-type: none"> 12 - Horizontal Brace 5 - Diagonal Brace 4 - 0.7m x 1.8m Door Base Frame 2 - 0.7m x 0.9m Upper Frame 2 - Access Platform 8 - 125mm Non-Adjustable Castor 2 - End Toeboard 2 - Side Toeboard 2 - Outrigger Prop 1.2m 4 - Doorway Frame Connector 	2.0m	Doorway 4	153kg



0.7m Single Width Mobile Towers



0.7m Single Width Towers

Height 2.0m

Platform height pre wheel adjustment: 2.05m
 Overall tower height including handrails: 3.05m
 Maximum reach/working height: 4.05m

Mobile Tower - Economy

Component List

- 6 - Horizontal Brace
- 3 - Diagonal Brace
- 2 - 0.7m x 0.9m Upper Frame
- 2 - 0.7m x 1.9m Base Frame
- 1 - Access Platform
- 1 - 1.8m Ladder
- 4 - 200mm HD Adjustable Castor
- 2 - End Toeboard
- 2 - Side Toeboard
- 2 - Outrigger Prop 1.2m



Length	Code	Approx Wgt
2.0m	Single2/20	117kg
2.5m	Single2/25	127kg
3.0m	Single2/30	139kg

Mobile Tower - Full Spec

Component List

- 6 - Horizontal Brace
- 3 - Diagonal Brace
- 2 - 0.7m x 0.9m Upper Frame
- 2 - 0.7m x 1.9m Base Frame
- 1 - Access Platform
- 1 - 1.8m Ladder
- 4 - 200mm HD Adjustable Castor
- 2 - End Toeboard
- 2 - Side Toeboard
- 4 - Outrigger Prop 1.2m



Length	Code	Approx Wgt
2.0m	SSA2/20	123kg
2.5m	SSA2/25	135kg
3.0m	SSA2/30	146kg

0.7m Single Width Towers

Height 2.5m

Platform height pre wheel adjustment: 2.52m
 Overall tower height including handrails: 3.52m
 Maximum reach/working height: 4.52m

Mobile Tower - Economy

Component List

- 6 - Horizontal Brace
- 4 - Diagonal Brace
- 2 - 0.7m x 1.4m Upper Frame
- 2 - 0.7m x 1.9m Base Frame
- 1 - Access Platform
- 1 - 1.8m Ladder
- 4 - 200mm HD Adjustable Castor
- 2 - End Toeboard
- 2 - Side Toeboard
- 2 - Outrigger Prop 1.2m



Length	Code	Approx Wgt
2.0m	Single2.5/20	123kg
2.5m	Single2.5/25	136kg
3.0m	Single2.5/30	150kg

0.7m Single Width Towers

Height 3.0m

Platform height pre wheel adjustment: 2.98m
 Overall tower height including handrails: 3.98m
 Maximum reach/working height: 4.98m

Mobile Tower - Economy

Component List

- 6 - Horizontal Brace
- 4 - Diagonal Brace
- 2 - 0.7m x 0.9m Upper Frame
- 2 - 0.7m x 1.9m Base Frame
- 1 - 0.7m x 1.9m Upper Frame
- 1 - Access Platform
- 1 - 3.0m Ladder
- 4 - 200mm HD Adjustable Castor
- 2 - End Toeboard
- 2 - Side Toeboard
- 2 - Outrigger Prop 3.0m



Length	Code	Approx Wgt
2.0m	Single3/20	133kg
2.5m	Single3/25	142kg
3.0m	Single3/30	157kg

Mobile Tower - with extra deck for safe assembly

Component List

- 8 - Horizontal Brace
- 3 - Diagonal Brace
- 2 - 0.7m x 0.9m Upper Frame
- 2 - 0.7m x 1.9m Base Frame
- 1 - 0.7m x 1.9m Upper Frame
- 1 - Standard Platform
- 1 - Access Platform
- 1 - 1.8m Ladder
- 4 - 200mm HD Adjustable Castor
- 2 - End Toeboard
- 2 - Side Toeboard
- 2 - Outrigger Prop 3.0m



Length	Code	Approx Wgt
2.0m	SS3/20	147kg
2.5m	SS3/25	165kg
3.0m	SS3/30	181kg

0.7m Single Width Towers

Height 3.0m

Platform height pre wheel adjustment: 2.98m
 Overall tower height including handrails: 3.98m
 Maximum reach/working height: 4.98m

Mobile Tower - Safe assembly Full Spec

Component List

- 8 - Horizontal Brace
- 3 - Diagonal Brace
- 2 - 0.7m x 0.9m Upper Frame
- 2 - 0.7m x 1.9m Base Frame
- 1 - 0.7m x 1.9m Upper Frame
- 1 - Standard Platform
- 1 - Access Platform
- 1 - 1.8m Ladder
- 4 - 200mm HD Adjustable Castor
- 2 - End Toeboard
- 2 - Side Toeboard
- 4 - Outrigger Prop 3.0m



Length	Code	Approx Wgt
2.0m	SSA3/20	160kg
2.5m	SSA3/25	178kg
3.0m	SSA3/30	194kg

Height 3.5m

Platform height pre wheel adjustment: 3.45m
 Overall tower height including handrails: 4.45m
 Maximum reach/working height: 5.45m

Mobile Tower - Economy

Component List

- 6 - Horizontal Brace
- 5 - Diagonal Brace
- 2 - 0.7m x 0.9m Upper Frame
- 2 - 0.7m x 1.4m Upper Frame
- 2 - 0.7m x 1.9m Base Frame
- 1 - Access Platform
- 1 - 3.0m Ladder
- 4 - 200mm HD Adjustable Castor
- 2 - End Toeboard
- 2 - Side Toeboard
- 2 - Outrigger Prop 3.0m



Length	Code	Approx Wgt
2.0m	Single3.5/20	141kg
2.5m	Single3.5/25	155kg
3.0m	Single3.5/30	167kg

0.7m Single Width Towers

Height 4.0m

Platform height pre wheel adjustment: 3.91m
 Overall tower height including handrails: 4.91m
 Maximum reach/working height: 5.91m

Mobile Tower - Economy

Component List

- 6 - Horizontal Brace
- 5 - Diagonal Brace
- 2 - 0.7m x 0.9m Upper Frame
- 2 - 0.7m x 1.9m Base Frame
- 2 - 0.7m x 1.9m Upper Frame
- 1 - Access Platform
- 1 - 3.6m Ladder
- 4 - 200mm HD Adjustable Castor
- 2 - End Toeboard
- 2 - Side Toeboard
- 2 - Outrigger Prop 3.0m



Length	Code	Approx Wgt
2.0m	Single4/20	146kg
2.5m	Single4/25	160kg
3.0m	Single4/30	171kg

Mobile Tower - with extra deck for safe assembly

Component List

- 8 - Horizontal Brace
- 4 - Diagonal Brace
- 2 - 0.7m x 0.9m Upper Frame
- 2 - 0.7m x 1.9m Base Frame
- 2 - 0.7m x 1.9m Upper Frame
- 2 - Access Platform
- 2 - 1.8m Ladder
- 4 - 200mm HD Adjustable Castor
- 2 - End Toeboard
- 2 - Side Toeboard
- 2 - Outrigger Prop 3.0m



Length	Code	Approx Wgt
2.0m	SS4/20	166kg
2.5m	SS4/25	184kg
3.0m	SS4/30	201kg

0.7m Single Width Towers

Height 4.0m

Platform height pre wheel adjustment: 3.91m
 Overall tower height including handrails: 4.91m
 Maximum reach/working height: 5.91m

Mobile Tower - Safe assembly Full Spec

Component List

- 10 - Horizontal Brace
- 4 - Diagonal Brace
- 2 - 0.7m x 0.9m Upper Frame
- 2 - 0.7m x 1.9m Base Frame
- 2 - 0.7m x 1.9m Upper Frame
- 2 - Access Platform
- 2 - 1.8m Ladder
- 4 - 200mm HD Adjustable Castor
- 4 - End Toeboard
- 4 - Side Toeboard
- 4 - Outrigger Prop 3.0m



Length	Code	Approx Wgt
2.0m	SSA4/20	195kg
2.5m	SSA4/25	217kg
3.0m	SSA4/30	238kg

Height 4.5m

Platform height pre wheel adjustment: 4.38m
 Overall tower height including handrails: 5.38m
 Maximum reach/working height: 6.38m

Mobile Tower - Economy

Component List

- 6 - Horizontal Brace
- 6 - Diagonal Brace
- 2 - 0.7m x 1.4m Upper Frame
- 2 - 0.7m x 1.9m Base Frame
- 2 - 0.7m x 1.9m Upper Frame
- 1 - Access Platform
- 1 - 4.2m Ladder
- 4 - 200mm HD Adjustable Castor
- 2 - End Toeboard
- 2 - Side Toeboard
- 2 - Outrigger Prop 3.0m



Length	Code	Approx Wgt
2.0m	Single4.5/20	152kg
2.5m	Single4.5/25	168kg
3.0m	Single4.5/30	181kg

0.7m Single Width Towers

Height 5.0m

Platform height pre wheel adjustment: 4.84m
 Overall tower height including handrails: 5.84m
 Maximum reach/working height: 6.84m

Mobile Tower - Economy

Component List

- 6 - Horizontal Brace
- 6 - Diagonal Brace
- 2 - 0.7m x 0.9m Upper Frame
- 2 - 0.7m x 1.9m Base Frame
- 3 - 0.7m x 1.9m Upper Frame
- 1 - Access Platform
- 1 - 4.2m Ladder
- 4 - 200mm HD Adjustable Castor
- 2 - End Toeboard
- 2 - Side Toeboard
- 2 - Outrigger Prop 3.0m



Length	Code	Approx Wgt
2.0m	Single5/20	158kg
2.5m	Single5/25	172kg
3.0m	Single5/30	185kg

Mobile Tower - with extra deck for safe assembly

Component List

- 8 - Horizontal Brace
- 5 - Diagonal Brace
- 2 - 0.7m x 0.9m Upper Frame
- 2 - 0.7m x 1.9m Base Frame
- 3 - 0.7m x 1.9m Upper Frame
- 2 - Access Platform
- 2 - 2.4m Ladder
- 4 - 200mm HD Adjustable Castor
- 2 - End Toeboard
- 2 - Side Toeboard
- 2 - Outrigger Prop 3.0m



Length	Code	Approx Wgt
2.0m	SS5/20	160kg
2.5m	SS5/25	199kg
3.0m	SS5/30	213kg

Mobile Tower - Safe assembly Full Spec

Component List

- 12 - Horizontal Brace
- 5 - Diagonal Brace
- 2 - 0.7m x 0.9m Upper Frame
- 2 - 0.7m x 1.9m Base Frame
- 3 - 0.7m x 1.9m Upper Frame
- 3 - Access Platform
- 2 - 1.8m Ladder
- 4 - 200mm HD Adjustable Castor
- 4 - End Toeboard
- 4 - Side Toeboard
- 4 - Outrigger Prop 3.0m



Length	Code	Approx Wgt
2.0m	SSA5/20	225kg
2.5m	SSA5/25	254kg
3.0m	SSA5/30	279kg

0.7m Single Width Towers

Height 6.0m

Platform height pre wheel adjustment: 5.77m
 Overall tower height including handrails: 6.77m
 Maximum reach/working height: 7.77m

Mobile Tower - with extra deck for safe assembly

- Component List**
- 10 - Horizontal Brace
 - 5 - Diagonal Brace
 - 2 - 0.7m x 0.9m Upper Frame
 - 2 - 0.7m x 1.9m Base Frame
 - 4 - 0.7m x 1.9m Upper Frame
 - 3 - Access Platform
 - 3 - 1.8m Ladder
 - 4 - 200mm HD Adjustable Castor
 - 2 - End Toeboard
 - 2 - Side Toeboard
 - 2 - Outrigger Prop 3.0m



Length	Code	Approx Wgt
2.0m	SS6/20	211kg
2.5m	SS6/25	236kg
3.0m	SS6/30	258kg

Mobile Tower - Safe assembly Full Spec

- Component List**
- 14 - Horizontal Brace
 - 5 - Diagonal Brace
 - 2 - 0.7m x 0.9m Upper Frame
 - 2 - 0.7m x 1.9m Base Frame
 - 4 - 0.7m x 1.9m Upper Frame
 - 3 - Access Platform
 - 3 - 1.8m Ladder
 - 4 - 200mm HD Adjustable Castor
 - 6 - End Toeboard
 - 6 - Side Toeboard
 - 4 - Outrigger Prop 3.0m



Length	Code	Approx Wgt
2.0m	SSA6/20	257kg
2.5m	SSA6/25	290kg
3.0m	SSA6/30	319kg

1.3m Double Width Mobile Towers



1.3m Double Width Towers

Height 2.0m

Platform height pre wheel adjustment: 1.85m
 Overall tower height including handrails: 2.85m
 Maximum reach/working height: 3.85m

Static Tower - Economy Starter Bundle pack

Component List

- 1 - L x 1.3m Plan Brace
- 6 - Horizontal Brace
- 3 - Diagonal Brace
- 2 - 1.3m x 0.9m Upper Frame
- 2 - 1.3m x 1.9m Base Frame
- 1 - Standard Platform
- 1 - Access Platform
- 1 - 1.8m Ladder
- 4 - 150mm HD Adjustable Baseplate



Length	Code	Approx Wgt
2.0m	BHD220	109kg
2.5m	BHD225	115kg

Add wheel set, toeboards, more frames etc to this tower to make into a full commercial mobile tower

1.3m Double Width Towers

Height 2.0m

Platform height pre wheel adjustment: 2.05m
 Overall tower height including handrails: 3.05m
 Maximum reach/working height: 4.05m

Mobile Tower - Economy

Component List

- 1 - L x 1.3m Plan Brace
- 6 - Horizontal Brace
- 4 - Diagonal Brace
- 2 - 1.3m x 0.9m Upper Frame
- 2 - 1.3m x 1.9m Base Frame
- 1 - Standard Platform
- 1 - Access Platform
- 1 - 1.8m Ladder
- 4 - 200mm HD Adjustable Castor
- 2 - End Toeboard
- 2 - Side Toeboard



Length	Code	Approx Wgt
2.0m	Double2/20	138kg
2.5m	Double2/25	156kg
3.0m	Double2/30	168kg

Height 2.5m

Platform height pre wheel adjustment: 2.52m
 Overall tower height including handrails: 3.52m
 Maximum reach/working height: 4.52m

Mobile Tower - Economy

Component List

- 1 - L x 1.3m Plan Brace
- 6 - Horizontal Brace
- 4 - Diagonal Brace
- 2 - 1.3m x 1.4m Upper Frame
- 2 - 1.3m x 1.9m Base Frame
- 1 - Standard Platform
- 1 - Access Platform
- 1 - 2.4m Ladder
- 4 - 200mm HD Adjustable Castor
- 2 - End Toeboard
- 2 - Side Toeboard



Length	Code	Approx Wgt
2.0m	Double2.5/20	150kg
2.5m	Double2.5/25	157kg
3.0m	Double2.5/30	186kg

1.3m Double Width Towers

Height 3.0m

Platform height pre wheel adjustment: 2.98m
 Overall tower height including handrails: 3.98m
 Maximum reach/working height: 4.98m

Mobile Tower - Economy

Component List

- 1 - L x 1.3m Plan Brace
- 6 - Horizontal Brace
- 6 - Diagonal Brace
- 2 - 1.3m x 0.9m Upper Frame
- 2 - 1.3m x 1.9m Base Frame
- 1 - 1.3m x 1.9m Upper Frame
- 1 - Standard Platform
- 1 - Access Platform
- 1 - 3.0m Ladder
- 4 - 200mm HD Adjustable Castor
- 2 - End Toeboard
- 2 - Side Toeboard



Length	Code	Approx Wgt
2.0m	Double3/20	156kg
2.5m	Double3/25	164kg
3.0m	Double3/30	192kg

Mobile Tower - with single deck for safe assembly

Component List

- 1 - L x 1.3m Plan Brace
- 8 - Horizontal Brace
- 4 - Diagonal Brace
- 2 - 1.3m x 0.9m Upper Frame
- 2 - 1.3m x 1.9m Base Frame
- 1 - 1.3m x 1.9m Upper Frame
- 2 - Standard Platform
- 1 - Access Platform
- 1 - 3.0m Ladder
- 4 - 200mm HD Adjustable Castor
- 2 - End Toeboard
- 2 - Side Toeboard



Length	Code	Approx Wgt
2.0m	DS3/20	171kg
2.5m	DS3/25	195kg
3.0m	DS3/30	215kg

Mobile Tower - Safe assembly Full Spec

Component List

- 1 - L x 1.3m Plan Brace
- 8 - Horizontal Brace
- 4 - Diagonal Brace
- 2 - 1.3m x 0.9m Upper Frame
- 2 - 1.3m x 1.9m Base Frame
- 1 - 1.3m x 1.9m Upper Frame
- 2 - Standard Platform
- 1 - Access Platform
- 2 - 1.8m Ladder
- 4 - 200mm HD Adjustable Castor
- 2 - End Toeboard
- 2 - Side Toeboard



Length	Code	Approx Wgt
2.0m	DDA3/20	176kg
2.5m	DDA3/25	199kg
3.0m	DDA3/30	220kg

1.3m Double Width Towers

Height 3.5m

Platform height pre wheel adjustment: 3.45m
 Overall tower height including handrails: 4.45m
 Maximum reach/working height: 5.45m

Mobile Tower - Economy

Component List

- 1 - L x 1.3m Plan Brace
- 6 - Horizontal Brace
- 9 - Diagonal Brace
- 2 - 1.3m x 0.9m Upper Frame
- 2 - 1.3m x 1.4m Upper Frame
- 2 - 1.3m x 1.9m Base Frame
- 1 - Standard Platform
- 1 - Access Platform
- 1 - 3.0m Ladder
- 4 - 200mm HD Adjustable Castor
- 2 - End Toeboard
- 2 - Side Toeboard



Length	Code	Approx Wgt
2.0m	Double3.5/20	172kg
2.5m	Double3.5/25	180kg
3.0m	Double3.5/30	210kg

Mobile Tower - with single deck for safe assembly

Component List

- 1 - L x 1.3m Plan Brace
- 8 - Horizontal Brace
- 5 - Diagonal Brace
- 2 - 1.3m x 0.9m Upper Frame
- 2 - 1.3m x 1.4m Upper Frame
- 2 - 1.3m x 1.9m Base Frame
- 2 - Standard Platform
- 1 - Access Platform
- 1 - 3.0m Ladder
- 4 - 200mm HD Adjustable Castor
- 2 - End Toeboard
- 2 - Side Toeboard



Length	Code	Approx Wgt
2.0m	DS3.5/20	180kg
2.5m	DS3.5/25	204kg
3.0m	DS3.5/30	225kg

1.3m Double Width Towers

Height 3.5m

Platform height pre wheel adjustment: 3.45m
 Overall tower height including handrails: 4.45m
 Maximum reach/working height: 5.45m

Mobile Tower - with double deck for safe assembly

Component List

- 1 - L x 1.3m Plan Brace
- 8 - Horizontal Brace
- 5 - Diagonal Brace
- 2 - 1.3m x 0.9m Upper Frame
- 2 - 1.3m x 1.4m Upper Frame
- 2 - 1.3m x 1.9m Base Frame
- 2 - Standard Platform
- 2 - Access Platform
- 2 - 1.8m Ladder
- 4 - 200mm HD Adjustable Castor
- 2 - End Toeboard
- 2 - Side Toeboard



Length	Code	Approx Wgt
2.0m	DD3.5/20	199kg
2.5m	DD3.5/25	228kg
3.0m	DD3.5/30	252kg

Mobile Tower - Safe assembly Full Spec

Component List

- 1 - L x 1.3m Plan Brace
- 10 - Horizontal Brace
- 5 - Diagonal Brace
- 2 - 1.3m x 0.9m Upper Frame
- 2 - 1.3m x 1.4m Upper Frame
- 2 - 1.3m x 1.9m Base Frame
- 2 - Standard Platform
- 2 - Access Platform
- 2 - 1.8m Ladder
- 4 - 200mm HD Adjustable Castor
- 4 - End Toeboard
- 4 - Side Toeboard



Length	Code	Approx Wgt
2.0m	DDA3.5/20	218kg
2.5m	DDA3.5/25	250kg
3.0m	DDA3.5/30	279kg

1.3m Double Width Towers

Height 4.0m

Platform height pre wheel adjustment: 3.91m
 Overall tower height including handrails: 4.91m
 Maximum reach/working height: 5.91m

Mobile Tower - Economy

Component List

- 1 - L x 1.3m Plan Brace
- 6 - Horizontal Brace
- 9 - Diagonal Brace
- 2 - 1.3m x 0.9m Upper Frame
- 2 - 1.3m x 1.9m Base Frame
- 2 - 1.3m x 1.9m Upper Frame
- 1 - Standard Platform
- 1 - Access Platform
- 1 - 3.6m Ladder
- 4 - 200mm HD Adjustable Castor
- 2 - End Toeboard
- 2 - Side Toeboard



Length	Code	Approx Wgt
2.0m	Double4/20	178kg
2.5m	Double4/25	192kg
3.0m	Double4/30	216kg

Mobile Tower - with single deck for safe assembly

Component List

- 1 - L x 1.3m Plan Brace
- 8 - Horizontal Brace
- 5 - Diagonal Brace
- 2 - 1.3m x 0.9m Upper Frame
- 2 - 1.3m x 1.9m Base Frame
- 2 - 1.3m x 1.9m Upper Frame
- 2 - Standard Platform
- 1 - Access Platform
- 1 - 3.6m Ladder
- 4 - 200mm HD Adjustable Castor
- 2 - End Toeboard
- 2 - Side Toeboard



Length	Code	Approx Wgt
2.0m	DS4/20	186kg
2.5m	DS4/25	210kg
3.0m	DS4/30	231kg

Mobile Tower - with double deck for safe assembly

Component List

- 1 - L x 1.3m Plan Brace
- 8 - Horizontal Brace
- 4 - Diagonal Brace
- 2 - 1.3m x 0.9m Upper Frame
- 2 - 1.3m x 1.9m Base Frame
- 1 - 1.3m x 1.9m Upper Frame
- 2 - Standard Platform
- 1 - Access Platform
- 2 - 1.8m Ladder
- 4 - 200mm HD Adjustable Castor
- 2 - End Toeboard
- 2 - Side Toeboard



Length	Code	Approx Wgt
2.0m	DD4/20	204kg
2.5m	DD4/25	232kg
3.0m	DD4/30	257kg

1.3m Double Width Towers

Height 4.0m

Platform height pre wheel adjustment: 3.91m
 Overall tower height including handrails: 4.91m
 Maximum reach/working height: 5.91m

Mobile Tower - Safe assembly Full Spec

Component List

- 1 - L x 1.3m Plan Brace
- 10 - Horizontal Brace
- 5 - Diagonal Brace
- 2 - 1.3m x 0.9m Upper Frame
- 2 - 1.3m x 1.9m Base Frame
- 2 - 1.3m x 1.9m Upper Frame
- 2 - Standard Platform
- 2 - Access Platform
- 2 - 1.8m Ladder
- 4 - 200mm HD Adjustable Castor
- 4 - End Toeboard
- 4 - Side Toeboard
- 4 - Outrigger Prop 3.0m



Length	Code	Approx Wgt
2.0m	DDA4/20	222kg
2.5m	DDA4/25	225kg
3.0m	DDA4/30	238kg

Height 4.5m

Platform height pre wheel adjustment: 4.38m
 Overall tower height including handrails: 5.38m
 Maximum reach/working height: 6.38m

Mobile Tower - Economy

Component List

- 1 - L x 1.3m Plan Brace
- 6 - Horizontal Brace
- 10 - Diagonal Brace
- 2 - 1.3m x 1.4m Upper Frame
- 2 - 1.3m x 1.9m Base Frame
- 2 - 1.3m x 1.9m Upper Frame
- 1 - Standard Platform
- 1 - Access Platform
- 1 - 4.2m Ladder
- 4 - 200mm HD Adjustable Castor
- 2 - End Toeboard
- 2 - Side Toeboard
- 2 - Outrigger Prop 3.0



Length	Code	Approx Wgt
2.0m	Double4.5/20	200kg
2.5m	Double4.5/25	209kg
3.0m	Double4.5/30	239kg

1.3m Double Width Towers

Height 5.0m

Platform height pre wheel adjustment: 4.84m
 Overall tower height including handrails: 5.84m
 Maximum reach/working height: 6.84m

Mobile Tower - Economy

Component List

- 1 - L x 1.3m Plan Brace
- 6 - Horizontal Brace
- 10 - Diagonal Brace
- 2 - 1.3m x 0.9m Upper Frame
- 2 - 1.3m x 1.9m Base Frame
- 3 - 1.3m x 1.9m Upper Frame
- 1 - Standard Platform
- 1 - Access Platform
- 1 - 4.2m Ladder
- 4 - 200mm HD Adjustable Castor
- 2 - End Toeboard
- 2 - Side Toeboard
- 2 - Outrigger Prop 3.0m



Length	Code	Approx Wgt
2.0m	Double5/20	206kg
2.5m	Double5/25	215kg
3.0m	Double5/30	245kg

Mobile Tower - with single deck for safe assembly

Component List

- 1 - L x 1.3m Plan Brace
- 8 - Horizontal Brace
- 6 - Diagonal Brace
- 2 - 1.3m x 0.9m Upper Frame
- 2 - 1.3m x 1.9m Base Frame
- 3 - 1.3m x 1.9m Upper Frame
- 2 - Standard Platform
- 1 - Access Platform
- 1 - 4.2m Ladder
- 4 - 200mm HD Adjustable Castor
- 2 - End Toeboard
- 2 - Side Toeboard
- 2 - Outrigger Prop 3.0m



Length	Code	Approx Wgt
2.0m	DS5/20	214kg
2.5m	DS5/25	238kg
3.0m	DS5/30	247kg

Mobile Tower - with double deck for safe assembly

Component List

- 1 - L x 1.3m Plan Brace
- 8 - Horizontal Brace
- 6 - Diagonal Brace
- 2 - 1.3m x 0.9m Upper Frame
- 2 - 1.3m x 1.9m Base Frame
- 3 - 1.3m x 1.9m Upper Frame
- 2 - Standard Platform
- 2 - Access Platform
- 2 - 2.4m Ladder
- 4 - 200mm HD Adjustable Castor
- 2 - End Toeboard
- 2 - Side Toeboard
- 2 - Outrigger Prop 3.0m



Length	Code	Approx Wgt
2.0m	DD5/20	233kg
2.5m	DD5/25	262kg
3.0m	DD5/30	270kg

1.3m Double Width Towers

Height 5.0m

Platform height pre wheel adjustment: 4.84m
 Overall tower height including handrails: 5.84m
 Maximum reach/working height: 6.84m

Mobile Tower - Safe assembly Full Spec

Component List

- 1 - L x 1.3m Plan Brace
- 12 - Horizontal Brace
- 6 - Diagonal Brace
- 2 - 1.3m x 0.9m Upper Frame
- 2 - 1.3m x 1.9m Base Frame
- 3 - 1.3m x 1.9m Upper Frame
- 3 - Standard Platform
- 2 - Access Platform
- 3 - 1.8m Ladder
- 4 - 200mm HD Adjustable Castor
- 4 - End Toeboard
- 4 - Side Toeboard
- 4 - Outrigger Prop 3.0m



Length	Code	Approx Wgt
2.0m	DDA5/20	288kg
2.5m	DDA5/25	327kg
3.0m	DDA5/30	338kg

Height 5.5m

Platform height pre wheel adjustment: 5.31m
 Overall tower height including handrails: 6.31m
 Maximum reach/working height: 7.31m

Mobile Tower - Economy

Component List

- 1 - L x 1.3m Plan Brace
- 10 - Horizontal Brace
- 13 - Diagonal Brace
- 2 - 1.3m x 0.9m Upper Frame
- 2 - 1.3m x 1.4m Upper Frame
- 2 - 1.3m x 1.9m Base Frame
- 2 - 1.3m x 1.9m Upper Frame
- 1 - Standard Platform
- 2 - Access Platform
- 1 - 1.8m Ladder
- 1 - 3.0m Ladder
- 4 - 200mm HD Adjustable Castor
- 2 - 0.7m End Toeboard
- 2 - 1.3m End Toeboard
- 4 - Side Toeboard
- 2 - Outrigger Prop 3.0m



Length	Code	Approx Wgt
2.0m	Double5.5/20	260kg
2.5m	Double5.5/25	273kg
3.0m	Double5.5/30	320kg

1.3m Double Width Towers

Height 6.0m

Platform height pre wheel adjustment: 5.77m
 Overall tower height including handrails: 6.77m
 Maximum reach/working height: 7.77m

Mobile Tower - Economy

Component List

- 1 - L x 1.3m Plan Brace
- 10 - Horizontal Brace
- 13 - Diagonal Brace
- 2 - 1.3m x 0.9m Upper Frame
- 2 - 1.3m x 1.9m Base Frame
- 4 - 1.3m x 1.9m Upper Frame
- 1 - Standard Platform
- 2 - Access Platform
- 1 - 1.8m Ladder
- 1 - 3.6m Ladder
- 4 - 200mm HD Adjustable Castor
- 2 - 0.7m End Toeboard
- 2 - 1.3m End Toeboard
- 4 - Side Toeboard
- 2 - Outrigger Prop 3.0m



Length	Code	Approx Wgt
2.0m	Double6/20	267kg
2.5m	Double6/25	280kg
3.0m	Double6/30	327kg

Mobile Tower - with single deck for safe assembly

Component List

- 1 - L x 1.3m Plan Brace
- 10 - Horizontal Brace
- 7 - Diagonal Brace
- 2 - 1.3m x 0.9m Upper Frame
- 2 - 1.3m x 1.9m Base Frame
- 4 - 1.3m x 1.9m Upper Frame
- 2 - Standard Platform
- 2 - Access Platform
- 1 - 1.8m Ladder
- 1 - 3.6m Ladder
- 4 - 200mm HD Adjustable Castor
- 2 - 1.3m End Toeboard
- 2 - Side Toeboard
- 2 - Outrigger Prop 3.0m



Length	Code	Approx Wgt
2.0m	DS6/20	252kg
2.5m	DS6/25	283kg
3.0m	DS6/30	310kg

Mobile Tower - with double deck for safe assembly

Component List

- 1 - L x 1.3m Plan Brace
- 10 - Horizontal Brace
- 7 - Diagonal Brace
- 2 - 1.3m x 0.9m Upper Frame
- 2 - 1.3m x 1.9m Base Frame
- 4 - 1.3m x 1.9m Upper Frame
- 3 - Standard Platform
- 3 - Access Platform
- 3 - 1.8m Ladder
- 4 - 200mm HD Adjustable Castor
- 2 - 1.3m End Toeboard
- 2 - Side Toeboard
- 27 2 - Outrigger Prop 3.0m



Length	Code	Approx Wgt
2.0m	DD6/20	284kg
2.5m	DD6/25	324kg
3.0m	DD6/30	358kg

1.3m Double Width Towers

Height 6.0m

Platform height pre wheel adjustment: 5.77m
 Overall tower height including handrails: 6.77m
 Maximum reach/working height: 7.77m

Mobile Tower - Safe assembly Full Spec

Component List

- 1 - L x 1.3m Plan Brace
- 14 - Horizontal Brace
- 7 - Diagonal Brace
- 2 - 1.3m x 0.9m Upper Frame
- 2 - 1.3m x 1.9m Base Frame
- 4 - 1.3m x 1.9m Upper Frame
- 3 - Standard Platform
- 3 - Access Platform
- 3 - 1.8m Ladder
- 4 - 200mm HD Adjustable Castor
- 6 - 1.3m End Toeboard
- 6 - Side Toeboard
- 4 - Outrigger Prop 3.0m



Length	Code	Approx Wgt
2.0m	DDA6/20	322kg
2.5m	DDA6/25	370kg
3.0m	DDA6/30	411kg

Height 6.5m

Platform height pre wheel adjustment: 6.24m
 Overall tower height including handrails: 7.24m
 Maximum reach/working height: 8.24m

Mobile Tower - Economy

Component List

- 1 - L x 1.3m Plan Brace
- 10 - Horizontal Brace
- 14 - Diagonal Brace
- 2 - 1.3m x 1.4m Upper Frame
- 2 - 1.3m x 1.9m Base Frame
- 4 - 1.3m x 1.9m Upper Frame
- 1 - Standard Platform
- 2 - Access Platform
- 1 - 2.4m Ladder
- 1 - 3.6m Ladder
- 4 - 200mm HD Adjustable Castor
- 2 - 0.7m End Toeboard
- 2 - 1.3m End Toeboard
- 4 - Side Toeboard
- 2 - Outrigger Prop 3.0m



Length	Code	Approx Wgt
2.0m	Double6.5/20	276kg
2.5m	Double6.5/25	289kg
3.0m	Double6.5/30	337kg

1.3m Double Width Towers

Height 7.0m

Platform height pre wheel adjustment: 6.70m
 Overall tower height including handrails: 7.70m
 Maximum reach/working height: 8.70m

Mobile Tower - Economy

Component List

- 1 - L x 1.3m Plan Brace
- 10 - Horizontal Brace
- 14 - Diagonal Brace
- 2 - 1.3m x 0.9m Upper Frame
- 2 - 1.3m x 1.9m Base Frame
- 5 - 1.3m x 1.9m Upper Frame
- 1 - Standard Platform
- 2 - Access Platform
- 1 - 2.4m Ladder
- 1 - 4.2m Ladder
- 4 - 200mm HD Adjustable Castor
- 2 - 0.7m End Toeboard
- 2 - 1.3m End Toeboard
- 4 - Side Toeboard
- 2 - Outrigger Prop 4.5m



Length	Code	Approx Wgt
2.0m	Double7/20	286kg
2.5m	Double7/25	297kg
3.0m	Double7/30	344kg

Mobile Tower - with single deck for safe assembly

Component List

- 1 - L x 1.3m Plan Brace
- 10 - Horizontal Brace
- 8 - Diagonal Brace
- 2 - 1.3m x 0.9m Upper Frame
- 2 - 1.3m x 1.9m Base Frame
- 5 - 1.3m x 1.9m Upper Frame
- 2 - Standard Platform
- 2 - Access Platform
- 1 - 2.4m Ladder
- 1 - 4.2m Ladder
- 4 - 200mm HD Adjustable Castor
- 2 - 1.3m End Toeboard
- 2 - Side Toeboard
- 2 - Outrigger Prop 4.5m



Length	Code	Approx Wgt
2.0m	DS7/20	272kg
2.5m	DS7/25	303kg
3.0m	DS7/30	330kg

Mobile Tower - with double deck for safe assembly

Component List

- 1 - L x 1.3m Plan Brace
- 10 - Horizontal Brace
- 8 - Diagonal Brace
- 2 - 1.3m x 0.9m Upper Frame
- 2 - 1.3m x 1.9m Base Frame
- 5 - 1.3m x 1.9m Upper Frame
- 3 - Standard Platform
- 3 - Access Platform
- 1 - 1.8m Ladder
- 2 - 2.4m Ladder
- 4 - 200mm HD Adjustable Castor
- 2 - 1.3m End Toeboard
- 2 - Side Toeboard
- 2 - Outrigger Prop 4.5m



Length	Code	Approx Wgt
2.0m	DD7/20	304kg
2.5m	DD7/25	344kg
3.0m	DD7/30	378kg

1.3m Double Width Towers

Height 8.0m

Platform height pre wheel adjustment: 7.63m
 Overall tower height including handrails: 8.63m
 Maximum reach/working height: 9.63m

Mobile Tower - with single deck for safe assembly

- Component List**
- 1 - L x 1.3m Plan Brace
 - 12 - Horizontal Brace
 - 9 - Diagonal Brace
 - 2 - 1.3m x 0.9m Upper Frame
 - 2 - 1.3m x 1.9m Base Frame
 - 6 - 1.3m x 1.9m Upper Frame
 - 3 - Standard Platform
 - 2 - Access Platform
 - 2 - 3.6m Ladder
 - 4 - 200mm HD Adjustable Castor
 - 2 - 1.3m End Toeboard
 - 2 - Side Toeboard
 - 2 - Outrigger Prop 4.5m



Length	Code	Approx Wgt
2.0m	DS8/20	306kg
2.5m	DS8/25	344kg
3.0m	DS8/30	376kg

Mobile Tower - with double deck for safe assembly

- Component List**
- 1 - L x 1.3m Plan Brace
 - 12 - Horizontal Brace
 - 9 - Diagonal Brace
 - 2 - 1.3m x 0.9m Upper Frame
 - 2 - 1.3m x 1.9m Base Frame
 - 6 - 1.3m x 1.9m Upper Frame
 - 4 - Standard Platform
 - 4 - Access Platform
 - 4 - 1.8m Ladder
 - 4 - 200mm HD Adjustable Castor
 - 2 - End Toeboard
 - 2 - Side Toeboard
 - 2 - Outrigger Prop 4.5m



Length	Code	Approx Wgt
2.0m	DD8/20	356kg
2.5m	DD8/25	407kg
3.0m	DD8/30	473kg

Tradesmen Multi Packs



Height 5.0m

Platform height pre wheel adjustment: 4.84m
 Overall tower height including handrails: 5.84m
 Maximum reach/working height: 6.84m

Single Width

Component List	Length	Code	Approx Wgt
10 - Horizontal Brace	2.0m	SSBC5/20	226kg
6 - Diagonal Brace			
2 - Outrigger Prop 1.2m	2.5m	SSBC5/25	250kg
2 - Outrigger Prop 3.0m			
4 - 0.7m x 0.9m Upper Frame	3.0m	SSBC5/30	272kg
2 - 0.7m x 1.9m Base Frame			
2 - 0.7m x 1.9m Upper Frame			
1 - Standard Platform			
2 - Access Platform			
2 - 2.4m Ladder			
4 - 200mm HD Adjustable Castor			
4 - 150mm HD Adjustable Baseplate			
2 - Handrail Post			
1 - Inline Truss Beam			

Double Width

Component List	Length	Code	Approx Wgt
2 - L x 1.3m Plan Brace	2.0m	DDBC5/20	284kg
12 - Horizontal Brace			
6 - Diagonal Brace	2.5m	DDBC5/25	323kg
2 - Outrigger Prop 3.0m			
4 - 1.3m x 0.9m Upper Frame	3.0m	DDBC5/30	356kg
2 - 1.3m x 1.9m Base Frame			
2 - 1.3m x 1.9m Upper Frame			
4 - Standard Platform			
2 - Access Platform			
2 - 2.4m Ladder			
4 - 200mm HD Adjustable Castor			
4 - 150mm HD Adjustable Baseplate			
2 - Handrail Post			
1 - Inline Truss Beam			

Quik-Guard Roof Edge Protection

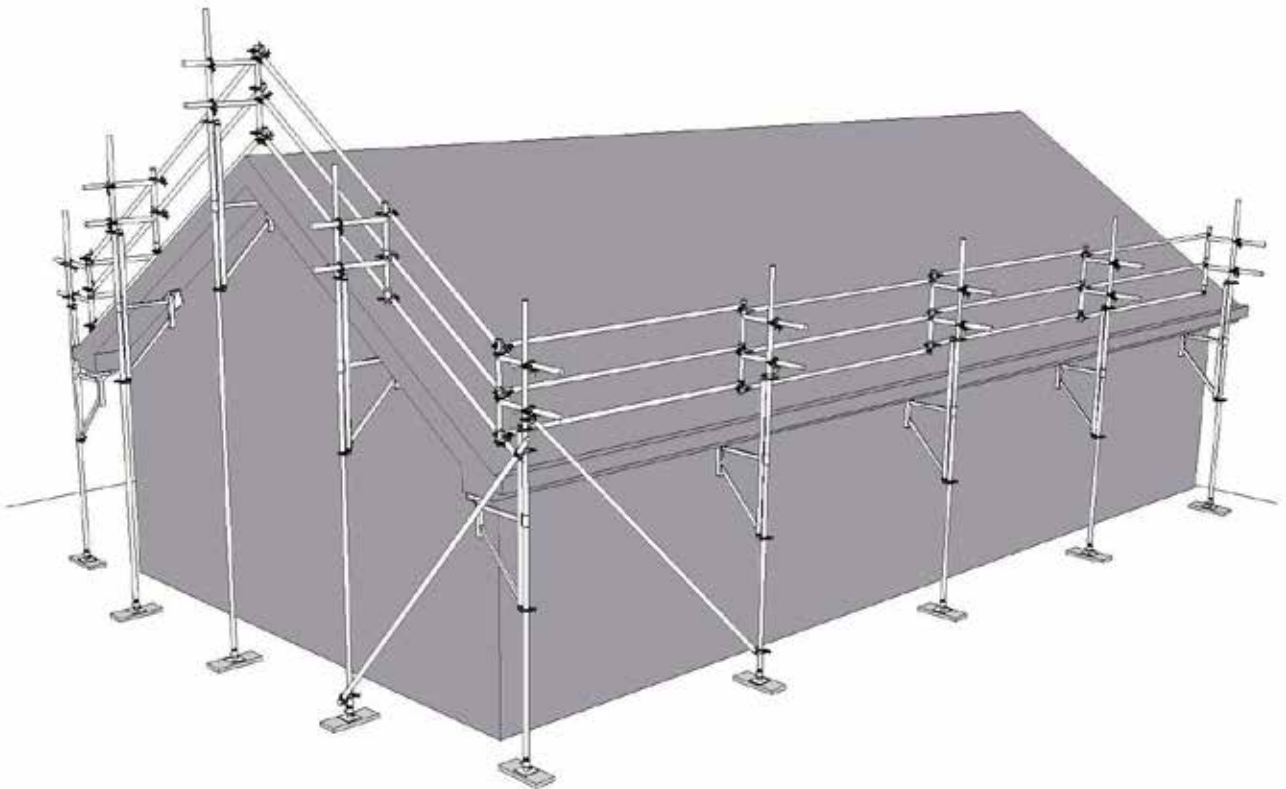

Lineal Metres 12

Component List

- 4 - Soffit Bracket
- 4 - Adjusting Tube
- 4 - Channel Bracket
- 4 - 150mm HD Adjustable Baseplate
- 4 - 48.4mm Wrapover Single Coupler
- 2 - 48.4mm Swivel Coupler w Wingnuts
- 8 - 48.4mm RA Double Coupler
- 3 - External Scaffold Pipe Joiner
- 11 - 48.4mm x 2.6mm Tube - 5.7m long

Code	Approx Wgt
REP12	118kg

Lineal Metres 36

Component List

- 10 - Soffit Bracket
- 10 - Adjusting Tube
- 10 - Channel Bracket
- 10 - 150mm HD Adjustable Baseplate
- 10 - 48.4mm Wrapover Single Coupler
- 6 - 48.4mm Swivel Coupler w Wingnuts
- 20 - 48.4mm RA Double Coupler
- 12 - External Scaffold Pipe Joiner
- 30 - 48.4mm x 2.6mm Tube - 5.7m long

Code	Approx Wgt
REP36	315kg

Lineal Metres 68

Component List

- 18 - Soffit Bracket
- 18 - Adjusting Tube
- 18 - Channel Bracket
- 18 - 150mm HD Adjustable Baseplate
- 18 - 48.4mm Wrapover Single Coupler
- 12 - 48.4mm Swivel Coupler w Wingnuts
- 36 - 48.4mm RA Double Coupler
- 21 - External Scaffold Pipe Joiner
- 60 - 48.4mm x 2.6mm Tube - 5.7m long

Code	Approx Wgt
REP68	602kg

Lineal Metres 104

Component List

27 - Soffit Bracket	Code	Approx Wgt
27 - Adjusting Tube		
27 - Channel Bracket	REP104	905kg
27 - 150mm HD Adjustable Baseplate		
27 - 48.4mm Wrapover Single Coupler		
18 - 48.4mm Swivel Coupler w Wingnuts		
54 - 48.4mm RA Double Coupler		
33 - External Scaffold Pipe Joiner		
90 - 48.4mm x 2.6mm Tube - 5.7m long		

Lineal Metres 200

Component List

51 - Soffit Bracket	Code	Approx Wgt
51 - Adjusting Tube		
51 - Channel Bracket	REP200	1708kg
51 - 150mm HD Adjustable Baseplate		
51 - 48.4mm Wrapover Single Coupler		
30 - 48.4mm Swivel Coupler w Wingnuts		
102 - 48.4mm RA Double Coupler		
60 - External Scaffold Pipe Joiner		
171 - 48.4mm x 2.6mm Tube - 5.7m long		

Components + Parts

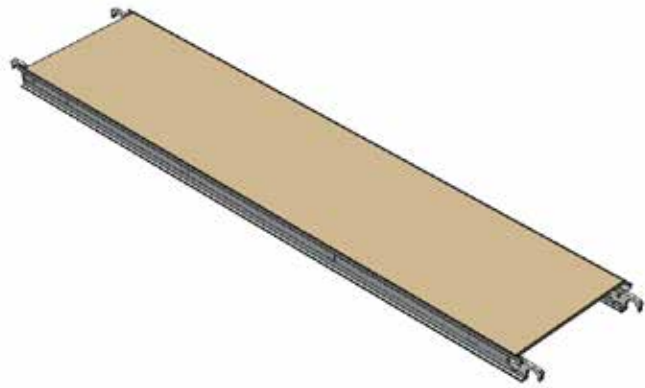

Frames - Standard

Size

Code

Approx Wgt

0.7m (single width) Standard Frames

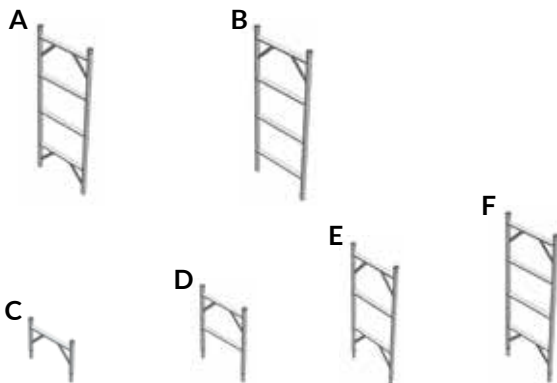

A	0.7m x 1.9m Base Frame	100104	7.0kg
B	0.7m x 1.8m Door Base Frame	100106	7.0kg
	0.7m x 1.8m Go-Gate Door Base Frame	101407	8.4kg
C	(1 rung) 0.7m x 0.5m Upper Frame	100100	2.7kg
D	(2 rung) 0.7m x 0.9m Upper Frame	100101	4.3kg
E	(3 rung) 0.7m x 1.4m Upper Frame	100103	6.2 kg
F	(4 rung) 0.7m x 1.9m Upper Frame	100105	7.7kg

1.3m (double width) Standard Frames

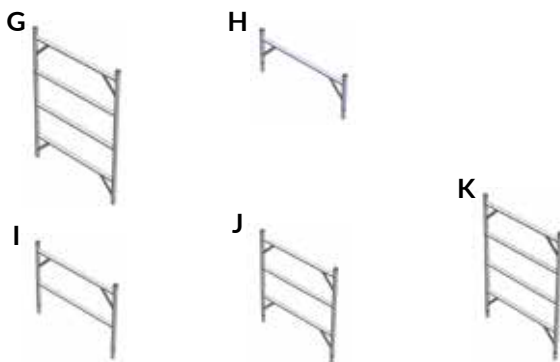

G	1.3m x 1.9m Base Frame	100114	9.7kg
	1.3m x 1.9m Go-Gate Base Frame	100116	
H	(1 rung) 1.3m x 0.5m Upper Frame	100110	3.3kg
I	(2 rung) 1.3m x 0.9m Upper Frame	100111	5.6kg
J	(3 rung) 1.3m x 1.4m Upper Frame	100113	8.0kg
K	(4 rung) 1.3m x 1.9m Upper Frame	100115	10.3kg

2.0m (triple width) Standard Frames

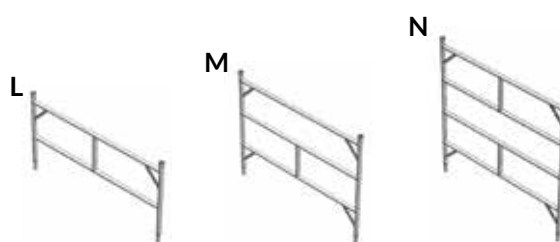

	(3 rung) 2.0m x 1.4m Base Frame	100122	9.6kg
	(4 rung) 2.0m x 1.9m Base Frame	100124	13.2kg
L	(2 rung) 2.0m x 0.9m Upper Frame	100121	7.3kg
M	(3 rung) 2.0m x 1.4m Upper Frame	100123	10.3kg
N	(4 rung) 2.0m x 1.9m Upper Frame	100125	13.8kg

3.0m (quintuple width) Standard Frames

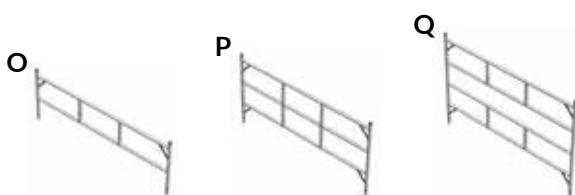

	(3 rung) 3.0m x 1.4m Base Frame	100142	14.2kg
	(4 rung) 3.0m x 1.9m Base Frame	100144	18.4kg
O	(2 rung) 3.0m x 0.9m Upper Frame	100141	10.3kg
P	(3 rung) 3.0m x 1.4m Upper Frame	100143	14.8kg
Q	(4 rung) 3.0m x 1.9m Upper Frame	100145	19.0kg

Frames - Special

Special Base Frames

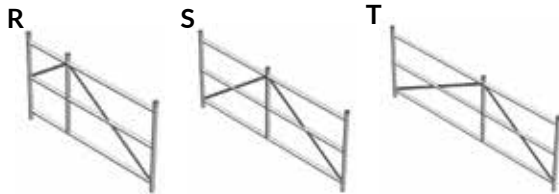

Size	Code	Approx Wgt
R 2.0m Extra-Wide Base Frame	100150	10.6kg
S 2.5m Extra-Wide Base Frame	100151	12.5kg
T 3.0m Extra-Wide Base Frame	100152	14.4kg

0.7m x 1.8m Go-Gate Door Base Frame	101407	8.4kg
1.3m x 1.9m Go-Gate Base Frame	100116	

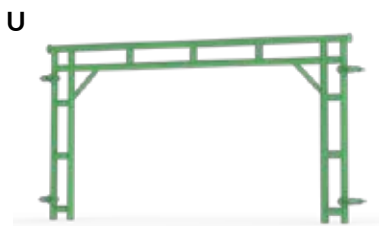

U 2.0m Stirrup Frame	100262	
2.5m Stirrup Frame	100263	
3.0m Stirrup Frame	100264	

Special Upper Frames



0.7m x 0.9m Clamp-on Frame	100108	4.3kg
V 0.7m x 1.4m Clamp-on Frame	100109	6.2kg
2.0m Inline Truss Beam	400222	
2.5m Inline Truss Beam	400223	
2.5m Inline Truss Beam	400224	
Handrail Post	400210	1.9kg

Walk Thru Frames

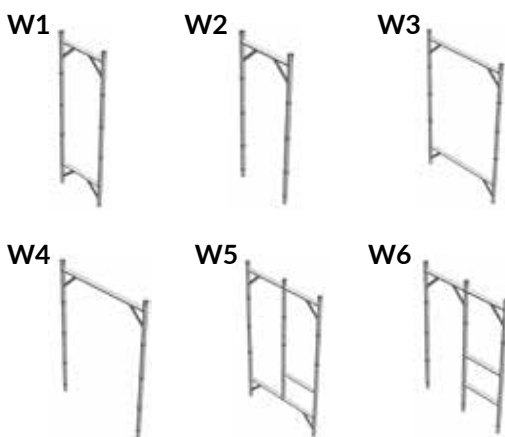

W1 0.7m Walk-Thru Base Frame	100220	7.0kg
W2 0.7m x 1.9m Walk-Thru Upper Frame	100224	6.7kg
W3 1.3m Walk-Thru Base Frame	100230	8.0kg
W4 1.3m x 1.9m Walk-Thru Upper Frame	100234	7.3kg
W5 1.3m Walk-Thru Ladder Access Base Frame	100240	11.5kg
W6 1.3m Walk-Thru Ladder Access Upper Frame	100241	11.7kg

Components

Braces

Horizontal Brace (yellow ends)



Diagonal Brace (silver ends)



Plan Brace (red ends)



Length	Code	Approx Wgt
0.7m	150120	1.3kg
1.3m	150121	1.9kg
2.0m	150122	2.5kg
2.5m	150123	3.1kg
3.0m	150124	3kg
0.7m	150129	
1.3m	150130	2.2kg
2.0m	150131	2.9kg
2.5m	150132	3.4kg
3.0m	150133	3.8g

Lgth x Wth	Code	Approx Wgt
1.3m x 1.3m	150101	2.4kg
2.0m x 1.3m	150102	3.0kg
2.5m x 1.3m	150104	3.5kg
3.0m x 1.3m	150107	3.9kg
2.0m x 2.0m	150103	3.4kg
2.5m x 2.0m	150105	3.8kg
3.0m x 2.0m	150108	4.2kg
2.5m x 3.0m	150109	4.9kg
3.0m x 3.0m	150110	

Handrail Trusses

Length	Code	Approx Wgt
2.5m	400215	7.5kg
3.0m	400216	9.0kg

Outrigger Props



Length	Code	Approx Wgt
1.2m	150152	3.8kg
3.0m	150150	6.3kg
4.5m	150151	7.9kg

Components

Platforms

Standard Platform

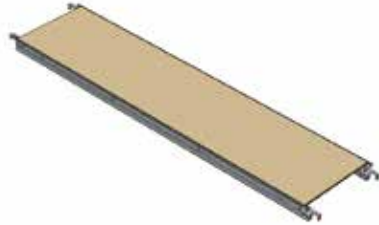

Length	Code	Approx Wgt
1.3m	200235	
2.0m	200240	14.5kg
2.5m	200250	19.0kg
3.0m	200260	22.5kg

Standard Platform



1.3m	200236	
2.0m	200241	14.5kg
2.5m	200251	19.0kg
3.0m	200261	22.5kg

Scaffold Ladders

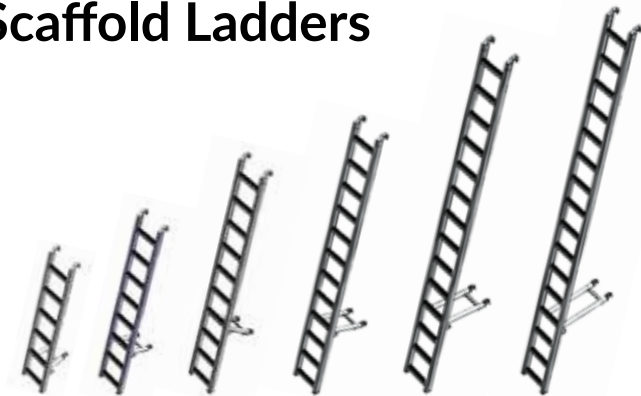

	Length		
6 Rung	1.8m	250101	7.9kg
8 Rung	2.4m	250102	9.5kg
10 Rung	3.0m	250103	11.0kg
12 Rung	3.6m	250104	12.7kg
14 Rung	4.2m	250105	14.4kg
16 Rung	4.8m	250106	16.9kg

Castors and Plates

	Size		
150mm Baseplate/Screwjack (steel)	300211	3.6kg	
150mm Swivel Baseplate/Screwjack	300200	3.6kg	
125mm Non-Adjustable Castor (TR)	300204	2.6kg	
200mm Castor/Screwjack (Taiwan) 500kg rated	300207	6.7kg	
200mm Castor/Screwjack (TR) 750kg rated	300202	6.6kg	

Components

Toeboards

	Ply Toeboards	Code	Approx Wgt
	0.7m End Toeboard	501401	1.6kg
	1.3m End Toeboard	501402	2.8kg
	2.0m End Toeboard	501403	4.1kg
	2.0m Side Toeboard	501408	4.1kg
	2.5m Side Toeboard	501409	5.5kg
	3.0m Side Toeboard	501410	6.7kg
	Aluminium Toeboards		
	0.7m End Toeboard Alloy	501411	1.92kg
	1.3m End Toeboard Alloy	501412	3.44kg
	2.0m End Toeboard Alloy	501413	4.97kg
	2.5m Side Toeboard Alloy	501419	6.62kg
	3.0m Side Toeboard Alloy	501420	8.19kg
	0.7m Gate Frame End Toeboard Bracket	500290	0.7kg
	1.3m Gate Frame End Toeboard Bracket	500291	2.22kg

Quik-Guard REP

	Item		
	Quik-Guard Soffit Bracket	801402	4.70kg
	Quik-Guard Adjusting Tube	801401	0.50kg
	Quik-Guard Channel Bracket	801405	0.50kg
	48.4mm Wrapover Single Coupler	9150122	0.60kg
	48.4mm Swivel Coupler w Wingnuts	9150119	1.20kg
	48.4mm RA Double Coupler	9151424	1.10kg
	External Scaffold Pipe Joiner	9150129	1.10kg
	48.4mm x 2.6mm Tube - 5.7m long	650407	5.77kg

Components

Parts

Description	Code	Approx Wgt
48.4mm x 2.6mm Alloy Spigot	9100120	0.5kg
Doorway Frame Connector	9100121	0.7kg
Plain Grasper Complete	9150101	0.4kg
Yellow Grasper Complete	9150102	0.4kg
Red Grasper Complete	9150103	0.4kg
Brace Grasper Repair Kit	9150211	0.1kg
SS6-5 Rive for graspers and spiggots	9550941	
Outrigger Clamp	9151421	0.7kg
Frame Locking Pin	9360207	
200mm Replacement Wheel only	9300215	1.05kg
125mm Replacement Wheel only	9300217	0.34kg
Access Hatch Replacement Ply only	601410	
2.0m Standard Platform Replacement Ply only	601411	
2.0m Access Platform Replacement Ply only	601412	
2.5m Standard Platform Replacement Ply only	601413	
2.5m Access Platform Replacement Ply only	601414	
3.0m Standard Platform Replacement Ply only	601415	
3.0m Access Platform Replacement Ply only	601516	
6-5 Flange Rivet for replacement ply	9550948	

The logo for MULTISCAFF features a stylized 'M' icon composed of three slanted parallel bars in white and green, positioned above the word 'MULTISCAFF'. 'MULTI' is in green and 'SCAFF' is in white.

Supplied by:



www.multiscaff.nz | sales@equiptec.co

0800 84 00 00 | +64 6 842 0222

